



# SuperSystems

incorporated

## eFlo 2.0

### HIGH PRESSURE / LIQUID FLOW METER



## OPERATIONS MA

По вопросам продаж и поддержки обращайтесь:

Алматы (7273)495-231  
Ангарск (3955)60-70-56  
Архангельск (8182)63-90-72  
Астрахань (8512)99-46-04  
Барнаул (3852)73-04-60  
Белгород (4722)40-23-64  
Благовещенск (4162)22-76-07  
Брянск (4832)59-03-52  
Владивосток (423)249-28-31  
Владикавказ (8672)28-90-48  
Владимир (4922)49-43-18  
Волгоград (844)278-03-48  
Вологда (8172)26-41-59  
Воронеж (473)204-51-73  
Екатеринбург (343)384-55-89

Иваново (4932)77-34-06  
Ижевск (3412)26-03-58  
Иркутск (395)279-98-46  
Казань (843)206-01-48  
Калининград (4012)72-03-81  
Калуга (4842)92-23-67  
Кемерово (3842)65-04-62  
Киров (8332)68-02-04  
Коломна (4966)23-41-49  
Кострома (4942)77-07-48  
Краснодар (861)203-40-90  
Красноярск (391)204-63-61  
Курск (4712)77-13-04  
Курган (3522)50-90-47  
Липецк (4742)52-20-81

Магнитогорск (3519)55-03-13  
Москва (495)268-04-70  
Мурманск (8152)59-64-93  
Набережные Челны (8552)20-53-41  
Нижний Новгород (831)429-08-12  
Новокузнецк (3843)20-46-81  
Ноябрьск (3496)41-32-12  
Новосибирск (383)227-86-73  
Омск (3812)21-46-40  
Орел (4862)44-53-42  
Оренбург (3532)37-68-04  
Пенза (8412)22-31-16  
Петрозаводск (8142)55-98-37  
Псков (8112)59-10-37  
Пермь (342)205-81-47

Ростов-на-Дону (863)308-18-15  
Рязань (4912)46-61-64  
Самара (846)206-03-16  
Санкт-Петербург (812)309-46-40  
Саратов (845)249-38-78  
Севастополь (8692)22-31-93  
Саранск (8342)22-96-24  
Симферополь (3652)67-13-56  
Смоленск (4812)29-41-54  
Сочи (862)225-72-31  
Ставрополь (8652)20-65-13  
Сургут (3462)77-98-35  
Сыктывкар (8212)25-95-17  
Тамбов (4752)50-40-97  
Тверь (4822)63-31-35

Тольятти (8482)63-91-07  
Томск (3822)98-41-53  
Тула (4872)33-79-87  
Тюмень (3452)66-21-18  
Ульяновск (8422)24-23-59  
Улан-Удэ (3012)59-97-51  
Уфа (347)229-48-12  
Хабаровск (4212)92-98-04  
Чебоксары (8352)28-53-07  
Челябинск (351)202-03-61  
Череповец (8202)49-02-64  
Чита (3022)38-34-83  
Якутск (4112)23-90-97  
Ярославль (4852)69-52-93

Россия +7(495)268-04-70







Казахстан +7(7172)727-132

Киргизия +996(312)96-26-47

Эл. почта: [sid@nt-rt.ru](mailto:sid@nt-rt.ru) || Сайт: <https://ssi.nt-rt.ru>

**Table of Contents**

Introduction..... 6  
    Model Numbers..... 6  
    Safety Information..... 7  
Specifications..... 7  
Installation Procedure ..... 8  
    Mechanical Installation ..... 8  
        Clearance..... 8  
        Mounting ..... 8  
        Plumbing..... 8  
        Thread Sealants:..... 9  
        Connection Tightness:..... 9  
        Leak Checking ..... 9  
    Electrical Installation ..... 10  
        Purging The eFlo-L..... 10  
Initial Network Configuration ..... 11  
    nLocateIP Method ..... 11  
Modbus Registers ..... 13  
eFlo Background and Familiarization..... 13  
Zero Adjustment & Calibration ..... 14  
Calibration Verification Procedure ..... 14  
Keypad Operating Procedure..... 15  
    Keypad Basic Functions ..... 15  
        View Totalized Flow ..... 15  
        Reset Totalized Flow ..... 16  
        Switch between Auto and Manual Modes ..... 16  
        Adjust Flow Rate (Manual Mode Only) ..... 16  
        Display Setpoint ..... 16  
        Adjust Setpoint..... 16  
        Display Alarm ..... 16  
        Enter Menu ..... 17  
    Keypad Setup Menu System..... 17  
        Setup Menu Keypad Functions ..... 17  
        Exiting the Menu System ..... 19  
    Menu System Details..... 19

Touchscreen Operating Procedure.....	20
Touchscreen Basic Functions .....	21
View Active Alarms .....	22
View Totalized Flow .....	22
Reset Totalized Flow .....	22
Switch between Auto and Manual Modes.....	22
Adjust Flow Rate (Manual Mode Only).....	23
Adjust Setpoint.....	23
Settings Menu.....	24
Instrument Information & Diagnostics Menu.....	24
 Basic Configuration Menu .....	25
 Basic Configuration - Flow Alarm Menu.....	25
 Network Configuration - Serial Communications Menu.....	26
 Network Configuration - Ethernet Communications Menu .....	26
 Instrument Configuration - Gas Menu.....	27
 Instrument Configuration – Addition Options Menu.....	27
Maintenance.....	28
Web Interface.....	28
Using the Web Interface .....	28
Main Screen.....	29
Instrument Information .....	29
Diagnostics .....	30
Basic Configuration .....	30
Instrument Configuration .....	32
Read/Write Registers .....	33
Network Configuration .....	33
Alarms.....	35
Troubleshooting .....	36
Warranty.....	38
Revision History .....	39
Appendix 1: Overall Dimensions of Assembled Meter.....	40
Appendix 2: Zero Tare & Zero Calibration Procedures .....	41

eFlo-H & eFlo-L Electronic High Pressure Flow Meter Operations Manual

Zero Tare: .....	41
Zero Calibration: .....	42
Appendix 3: Menu Option Tables.....	44
Appendix 4: Calibration Verification Procedure.....	45
Sensor Accuracy Verification .....	46

### Introduction

The **eFlo-H 2.0** (high pressure gas) and **eFlo-L 2.0** (high pressure liquid) (from hereon referred to as eFlo or eFlo 2.0) instruments are Super Systems Inc.'s electronic flow meters for higher pressure applications. eFlo works by measuring the differential pressure (the difference in pressure at two points) of a gas or liquid flowing through a specially designed opening in the flow assembly. Based on properties of the flowed gas or liquid (a.k.a. media), the differential pressure can then be used to calculate the flow rate of the media.

The eFlo 2.0 uses a mathematical curve to calculate the flow of a gas and features built-in diagnostic information, flow rate, pressure alarms, and a flow rate totalizer. The automatic meter can be set to automatic or manual valve control mode. Automatic valve control mode allows the eFlo to use a flow rate or valve position setpoint as a basis for adjusting the valve (and thus the gas flow) using a built-in valve motor. The setpoint can be programmed manually by the user or obtained by the instrument from a 4-20 mA analog signal or a digital signal over RS485. Manual valve control mode allows the user to manually set the valve position through the interface.

eFlo 2.0 is built for use in harsh industrial environments.

This manual also covers configuration and control using the eFlo web interface.

### Model Numbers

eFlo 2.0 model numbers provide details about your eFlo device's interface type, valve type, and gas type. This is useful information to have available when contacting SSI for technical support.

#### Interface Type

KP= Keypad Interface  
TS=Touchscreen Interface

#### Valve Type

A=Automatic Valve

#### Gas Type

AIR - Air	H2 - Hydrogen
ARG - Argon	MULT - Multiple Gasses
C3H8 - Propane	N2 - Nitrogen
CH4 - Methane	N2O - Nitrous Oxide
CO2 - Carbon Dioxide	NAT - Natural Gas
CRS - Coarse (AutoGen Special)	NH3 - Ammonia
DA - Disassociated Ammonia	PROY - Propylene Gas (C3H6)
ENDO - Endothermic Gas	TRM - Trim (AutoGen Special)

Example:

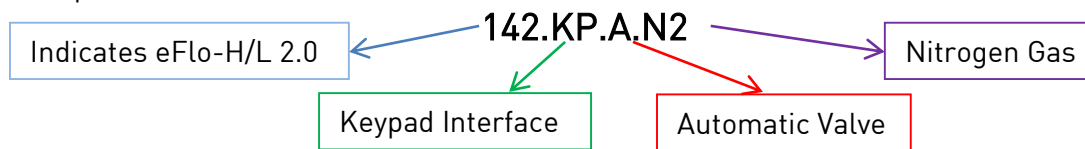

Safety Information

Observe the following safety requirements when configuring, operating, servicing, or maintaining the eFlo instrumentation. If the device is used in a manner not specified in this manual, protection provided by the equipment may be impaired.

**WARNING!**

The eFlo instrument is NOT guaranteed to provide media shutoff, nor is it designed to do so. For reliable media shutoff, incorporate a valve that provides positive media shutoff. Ensure that all media flow equipment is in compliance with National Fire Protection Agency (NFPA) requirements, including those found in NFPA 86. Failure to follow these requirements could result in flammable media leaks into the unit.

Ensure that the air and gas/liquid mixture ratio settings are within the specifications provided in this manual. Exceeding specified values could result in hazardous conditions.

**Specifications**

The specifications for the eFlo instrument are as follows.

Weight (Including Electronics Housing)	eFlo-H: 6.2 lb (2.8 kg) eFlo-L: 10.8 lb (4.9 kg)
Power Required	24 VDC @ 750 mA
Accuracy	4%
Repeatability	2%
Turndown Ratio	6:1
Medium Temperature Limits	-10°F to 125°F (-20°C to 51°C)
Ambient Temperature Limits	-10°F to 125°F (-20°C to 51°C)
Maximum Altitude	N/A
Flow Output Signal (Linear)	4-20 mA
Maximum Output Signal Load	500Ω
Input Control Signal (Linear)	4-20 mA
Communications	RS485, Ethernet, USB
Communication Protocol	Modbus RTU
Pressure Drop @ 100% Capacity	1 psi – standard liquid & gas <i>(5 psi optional when required)</i>
Flow Meter Pressure Limits  <i>The pressure will be calibrated to user-specified requirements.</i>  <i>See the Calibration Report included with your product for more details.</i>	5 psig gas & liquid – minimum allowable 80 psig gas – maximum allowable 50 psig liquid – maximum allowable

eFlo-H & eFlo-L Specifications

## Installation Procedure

Installing the eFlo unit consists of a mechanical installation and an electrical installation. The mechanical installation includes mounting as well as inlet and outlet piping. The eFlo unit will be assembled prior to shipment. Before beginning installation:

- Ensure that all fittings and connections are tightly secured prior to beginning installation.
- Ensure that all expected components are present. Contact SSI at (513) 772-0060 if you have questions.

### Mechanical Installation

#### *Clearance*

When installing the device, leave enough room on either side (3" is recommended) to allow users to adjust, remove, and replace the existing fittings. Also ensure that the device is installed in a location that allows for easy access to the power connection.

#### *Mounting*

Proper mounting is essential for the successful operation of the eFlo instrument. The eFlo main body and electronic housing can be mounted together or separately depending on the customer's requirements. The main body of the eFlo contains four (4) threaded holes for mounting to a panel. The holes are 1/4"-20 threaded and approximately 3/8" deep positioned in a row (see dimensional drawings in [Appendix 1](#)). The eFlo assembly can also be supported by inlet & outlet piping without using the mounting holes if desired. However, ensure that the pipe is rigid enough to support the weight of the meter assembly if mounting in this manner.

The electronics enclosure comes attached to the top of the meter main body (see [Appendix 1](#)). The enclosure can be mounted remotely as well (up to 20' away) depending on the customer's requirements. Cabling between the main body and electronic enclosure is possible with a remote display kit. Please contact SSI if there are any questions or concerns about mounting the electronic enclosure remotely.

The direction of flow through the meter is critical since the pressure transducer has a high pressure and low pressure side specifically required. The meter is designed for flow as indicated in [Appendix 1](#).

SSI recommends mounting the eFlo vertically with the media flow direction upwards. This is especially important for the eFlo-L used for liquids. If another orientation is required, please contact SSI prior to mounting.

#### *Plumbing*

The media inlet and outlet openings have 1/2" NPT connections. The locations of these connections are shown in [Appendix 1](#). Use of bushings or reducers at these connections is acceptable as long as the smallest pipe diameter is not smaller than the installed orifice plate. See certification for that meter to determine actual orifice diameter. Contact SSI at (513) 772-0060 for questions about pipe sizing.

*Thread Sealants:*

Teflon or natural gas-rated pipe tape or pipe dope is acceptable for non-corrosive gases. For corrosive gases, pipe tape is not recommended, unless the manufacturer specifies that it is rated for the gas being flowed through the meter.

NOTE: When installing the device, ensure that excessive tape or dope does not fall into the meter, as this can damage sensors, plug sensor lines, prevent flow through the meter, and prevent the device from functioning properly.

*Connection Tightness:*

After thread sealant is applied, tighten all connections by hand (3.5-6 turns, depending on pipe size), then use the following Turn Past Finger Tightness guide to complete the tightening process:

NPT Fitting Size	TPFT (Turns Past Finger Tightness)
1/8"	1.5-2.5
1/4"	1.5-2.5
3/8"	1.5-2.5
1/2"	1.5-2.5
3/4"	1.5-2.5
1"	1-2.5
1 1/4"	1-2.5
1 1/2"	1-2.5
2"	1-2.5

TPFT Guide

NOTE: Never loosen a fitting for correct alignment. Doing so will prevent the thread from maintaining a proper seal.

CAUTION: Do not overtighten the connection. Overtightening can damage threads, pipes, fittings, and the eFlo device.

*Leak Checking*

Before operation, all plumbed components should be leak checked. To avoid damage to sensors and other components, check with SSi for the maximum pressure for the sensor in your eFlo device (the installed sensor may vary based on the parameters needed in your particular application).

**IMPORTANT!**

Ensure that the inlet pressure is within specified parameters for your eFlo unit.



Electrical Installation

The eFlo meter requires a 10-pin connector and cable for power and communications. The eFlo is supplied with a 20 ft cable. The wires are color-coded per the table below. Contact SSI for a longer cable is required.

Wire-In Color	Signal Type	Description
Red	+ VDC	Power Supply (24 VDC @ 750mA)
Black	- VDC	
Green / Black Stripe	+ RS485	Communications Signal Provided by Modbus Over Serial
Red / Black Stripe	- RS485	
White / Black Stripe	RLY	Normally Open Relay Contact (24 VDC)
Orange / Black Stripe	RLY	
Orange	+ mA	Analog Out - Output Flow Signal (4 - 20 mA)
Blue	- mA	
Green	+ mA	Analog In - Input Setpoint Signal (4 - 20 mA)
White	- mA	

**Electrical Connections**

*Purging The eFlo-L*

The eFlo-L is used for liquid flow applications. After physical installation, all of the air needs to be purged from the eFlo-L main body and pressure transducer plumbing. The presence of gases in the meter can cause false and unstable flow readings.

Three bleed screws are on the side of the unit (2 for low pressure port, 1 for high pressure port).

- Install the transducer in its intended location and pressurize the ports.
- Back off the first bleed screw mounted on the flat side of the sensor body (2 turns max.) until liquid begins to flow out.
- After only bubble-free liquid flows out, retighten the bleed screw.
- Repeat same procedure for the second set of bleed screws located on the round section of the low pressure fitting.



eFlo-L unit – showing compression tube fittings for liquid purging

If the meter exhibits erratic flows or shows flow when the valve is closed and pressure still applied, there is probably still air trapped in the meter. The meter may need to be oriented in different positions to allow the trapped air to escape.

## Initial Network Configuration

This section is intended for use by persons familiar with Ethernet network setup.

In order to work correctly, the eFlo unit must be properly configured for the network to which it is connected.

**NOTE:** By default, the IP address of the eFlo unit is static, and Dynamic Host Configuration Protocol (DHCP) is disabled. These settings can be adjusted through SSI's *nLocateIP* software (see below), the web interface ([Using the Web Interface](#)), or through the eFlo keypad.

If you already know the IP address of the web interface, skip to the **Error! Reference source not found.** The network configuration is described in this section.

The eFlo unit will use a default IP address of 192.168.1.200. If the unit is using the default IP address, that IP address can be used to access the web interface (for more information on the web interface, refer to the **Error! Reference source not found.** section).

The IP address of the unit can also be found by using SSI's *nLocateIP* software. This method is described in the following subsection.

### nLocateIP Method

Once the unit is connected to the network, you should be able to locate it using SSI's *nLocateIP* software. This program is available from SSI. To use it in locating the unit on the network, follow these steps on a Windows-based PC:

1. Ensure that the unit is connected to the network.
2. Open the *nLocateIP* program



3. Once the program opens, click the **Search** button. The program will begin searching for SSI devices connected to the network.

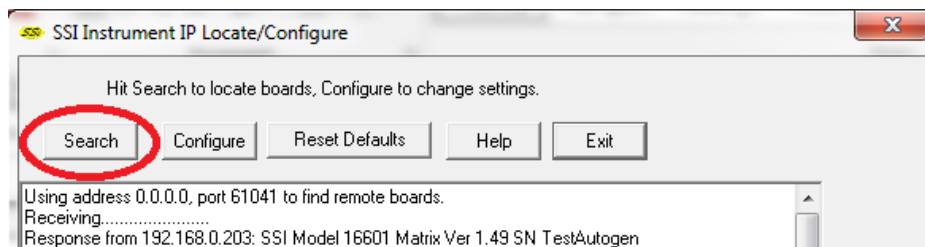

- Look for identifying text in the list of instruments. It includes the type of instrument and serial number. It also provides the IP Address information for the sensor.

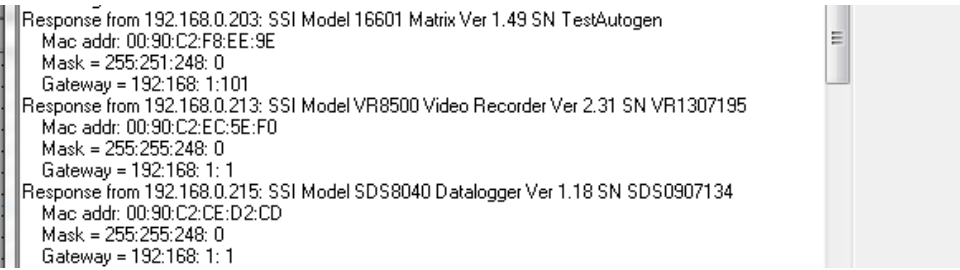

- Click the **Configure** button and choose the sensor to change its IP Address settings.

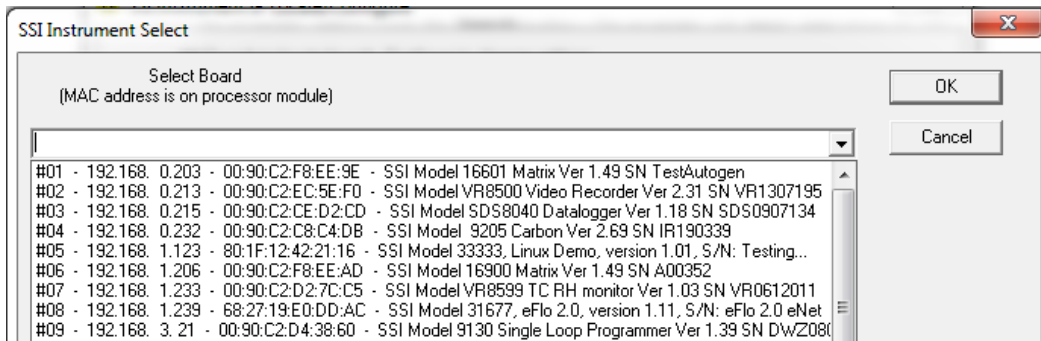

- Click on the device description to highlight it and click the **OK** button. This will display the device's IP settings, which can be changed to match the network to which it's connected.

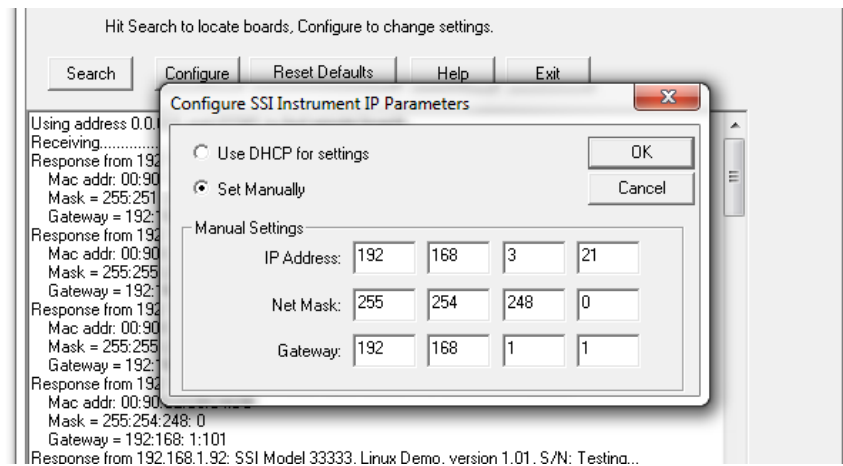

The sensor's IP Address settings will be changed immediately to allow it to communicate. If you are unable to find the unit in the list of devices, it is possible that a network setting (such as subnet mask) may be different, the unit may be connected to a different network, or the unit may not be powered on. SSI recommends consulting an IT engineer or network administrator. If needed, call SSI at (513) 772-0060.

## Modbus Registers

The eFlo Modbus registers are as follows.

Modbus Register Number	Description
16	Actual Flow
17	Flow Sensor mA Input Value
18	Flow Setpoint
19	Decimal Place for Display of Flow and Setpoint
20	Instrument Modbus Address
21	Not Used
22	Not Used
23	Not Used
24	Not Used
25	Not Used
26	Not Used
27	Not Used
28	Air Flow
29	Not Used
30	Not Used
31	Not Used
32	Not Used
33	Not Used
34	Not Used
35	Auto (1) / Manual (0) for Control
36	Not Used
37	Reset Totalizer Values to Zero
38	Not Used
39	Totalizer Units (0 to 9999)
40	Totalizer in 10,000s (0 to 9999 -> 0 to 99,990,000)
41	Totalizer in 10,000,000s (0 to 9999 -> 0 to 999,900,000,000)

Modbus Registers and Descriptions

## eFlo Background and Familiarization

The eFlo-H & eFlo-L meters are SSi's high pressure version of the *eFlo Electronic Flow Meter*. They also use the science of differential pressure to measure media flow through the meter, but can handle significantly higher supply pressures allowing it to be a more compact device. The meter is calibrated per the customer's specifications including media type, supply pressure, and media temperature. Accuracy of these three properties is critical and directly affects the accuracy of the meter. A certification is included with the meter defining the calibration conditions and customer's requirements. A curve providing the relationship between the differential pressure and the media flow is also indicated on the certification.

The meter assembly is separated into two categories; mechanical and electrical components. The mechanical portion of the meter includes all of the components that perform a mechanical

function to create flow. The electrical components include anything that involves electrical power in the function of the meter.

The meter controls the flow of media with the use of a linear stepper motor and valve assembly. As the flow increases, the differential pressure across the orifice plate increases. The differential pressure can be related directly to media flow if other significant properties are known. SSi calibrates every meter to match the characteristics of each fabricated orifice plate. This ensures accuracy of each meter.

### Zero Adjustment & Calibration

The differential pressure is measured with a differential pressure transducer in the eFlo-H and eFlo-L. This sensor does not measure absolute pressure (i.e. supply or line pressure), it only measures a difference in pressure on each side of the orifice plate in the meter. The diaphragm in the transducer is very sensitive to its orientation with respect to gravity. After shipping and installation, the diaphragm in the transducer may have shifted slightly. This can cause a flow reading to display on the meter when the valve is closed and the meter set point is zero. This is called **zero drift**. The meter must be zero'ed when you observe **zero drift**. There are two methods of zeroing the meter depending on the amount of **zero drift**.

There is an adjusted mA input based on the pressure transducer measurement when the flow rate is zero and supply pressure is applied to the meter. This mA value is known as the **zero value**. Ideally, the zero value will be 4.00 mA or slightly below.

- In a situation where pressure is applied to the inlet, no flow is present, and the mA reading is less than 4.25 mA or greater than 3.75 mA, a **Zero tare** in the field will often be required.
- If the mA zero value reading is greater than 4.25 mA or less than 3.75 mA, a **Zero calibration** is required.

The **Zero tare** and **Zero calibration** procedures are provided in [Appendix 2](#). This procedure will require the use to be familiar with the keypad or touchscreen in order to navigate through the meter and perform the function(s).

#### **IMPORTANT!**

For best long term results, it is recommended that pressure be maintained on the flow meter at all times. Pressure can be maintained when the shut off solenoid/valve is downstream from the outlet of the meter. This will ensure long term calibration and accuracy.

### Calibration Verification Procedure

The Calibration Verification Procedure can be found in [Appendix 4](#). This procedure will require the use to be familiar with the keypad or touchscreen in order to navigate through the meter and perform the function(s).

## Keypad Operating Procedure

The eFlo system is equipped with a pressure and flow rate alarm (high and low), flow rate totalizer, and integrated valve control. The unit can be operated in either manual or automatic mode for flow rate control. This section of the manual provides an explanation of the basic menu navigation through the keypad as well as how the unit operates including: valve control modes, flow limit control, flow alarming, flow totalizing, and programming of the unit.

The figure below shows the layout of the flow control panel on the Keypad eFlo 2.0 unit. An explanation of the panel's components is provided as well. The panel layout will be referenced further in this section.

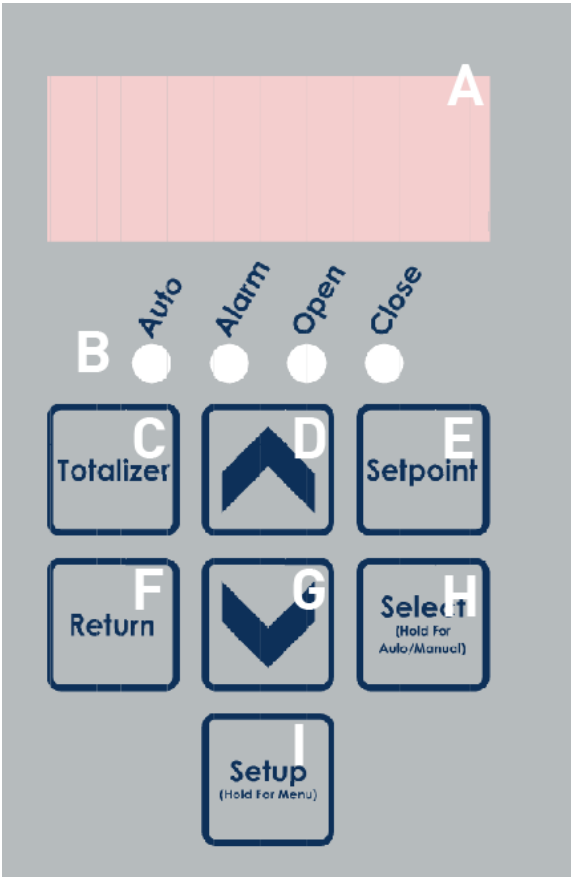

eFlo 2.0 LED Flow Control Panel Layout

### A – LED display

By default, the LED display is used to display the current flow. The LED display can also be used to show the totalizer value, current setpoint, and Setup menu options with associated settings. During active alarms, alarm status messages may also be displayed.

### B – Status indicators

These four lights come on in various situations:

**Auto:** When lit, the eFlo is in Auto valve control mode. When not lit, the unit is in Manual valve control mode.

**Alarm:** When lit, an alarm is active.

See [Alarms](#) section for more information.

**Open:** When lit, the valve is driving open.

**Close:** When lit, the valve is driving closed.

### C – Totalizer button

### D – Up button

### E – Setpoint button

### F – Return button

### G – Down button

### H – Select button

### I – Setup button

## Keypad Basic Functions



This section explains the most basic functionality of the eFlo 2.0. Additional options are available in the Setup menu and are explained in more detail in subsequent sections.

### View Totalized Flow

To view totalized flow, push . Hold the button down for a few seconds to show the full totalized numeric value by scrolling left.

The flow rate totalizer records cumulative flow rates measured by the meter. The totalizer is active at all times. The maximum totalized value is 999,999,999,999 (in any unit of flow measurement).

*Reset Totalized Flow*

To reset the totalized flow, push and hold  for five seconds. Then push  to confirm that the value has been reset to zero.

*Switch between Auto and Manual Modes*

To switch between Auto and Manual modes, hold  for five seconds. When in Auto mode, the Auto light (B) will be active. When in Manual mode, the Auto light (B) will not be active.

In Auto mode, the motorized valve will be automatically adjusted based on setpoint.



*Adjust Flow Rate (Manual Mode Only)*

To adjust the flow rate while in Manual mode, use  and .

*Display Setpoint*

To display the current setpoint, press .

*Adjust Setpoint*

To adjust the current setpoint, press and hold  and use  and .

NOTE: Setpoint can also be adjusted using one of the following methods:

1. Remote analog signal (4-20mA)
2. Remote digital signal with Modbus serial communications over RS485 – Register 18
3. Web interface (refer to [Main Screen](#))

It is important to note that the remote analog setpoint setting overwrites any manual setting. Therefore, if manual control of setpoint is desired, ensure that there is no external signal overwriting the manual setting.

*Display Alarm*

LED Display	Alarm
uNPr	Under pressure (factory set)
h iPr	High pressure (factory set)
Shut	Low flow issue (factory set)
h iLn	Valve is at its max open position (factory set)
LoFL	Low flow (user defined)

When an alarm is active, the Alarm light will turn on. A warning message will be displayed on the LED screen as shown. Setpoints for these alarms are set through a Modbus interface or by using the eFlo Web Interface. See [Alarms](#) section for more information.

h <sub>FL</sub>	High flow (user defined)
Lo <sub>Pr</sub>	Low pressure (user defined)
d <sub>EUR</sub>	Flow deviation (user defined)

### Enter Menu







To enter the Setup menu, hold  for five seconds.

### Keypad Setup Menu System

To enter the Setup menu, hold  for five seconds.

### Setup Menu Keypad Functions

When you first enter the setup menu, the eFlo will display P 100 (the current menu option).

To navigate the setup menu, use  and  to move vertically through the menu options, and use  and  to move horizontally through the menu options. (Think of  and  as your Right and Left buttons while navigating the menus (see the Visualization of Menu Navigation Functions).



Visualization of Menu Navigation Functions



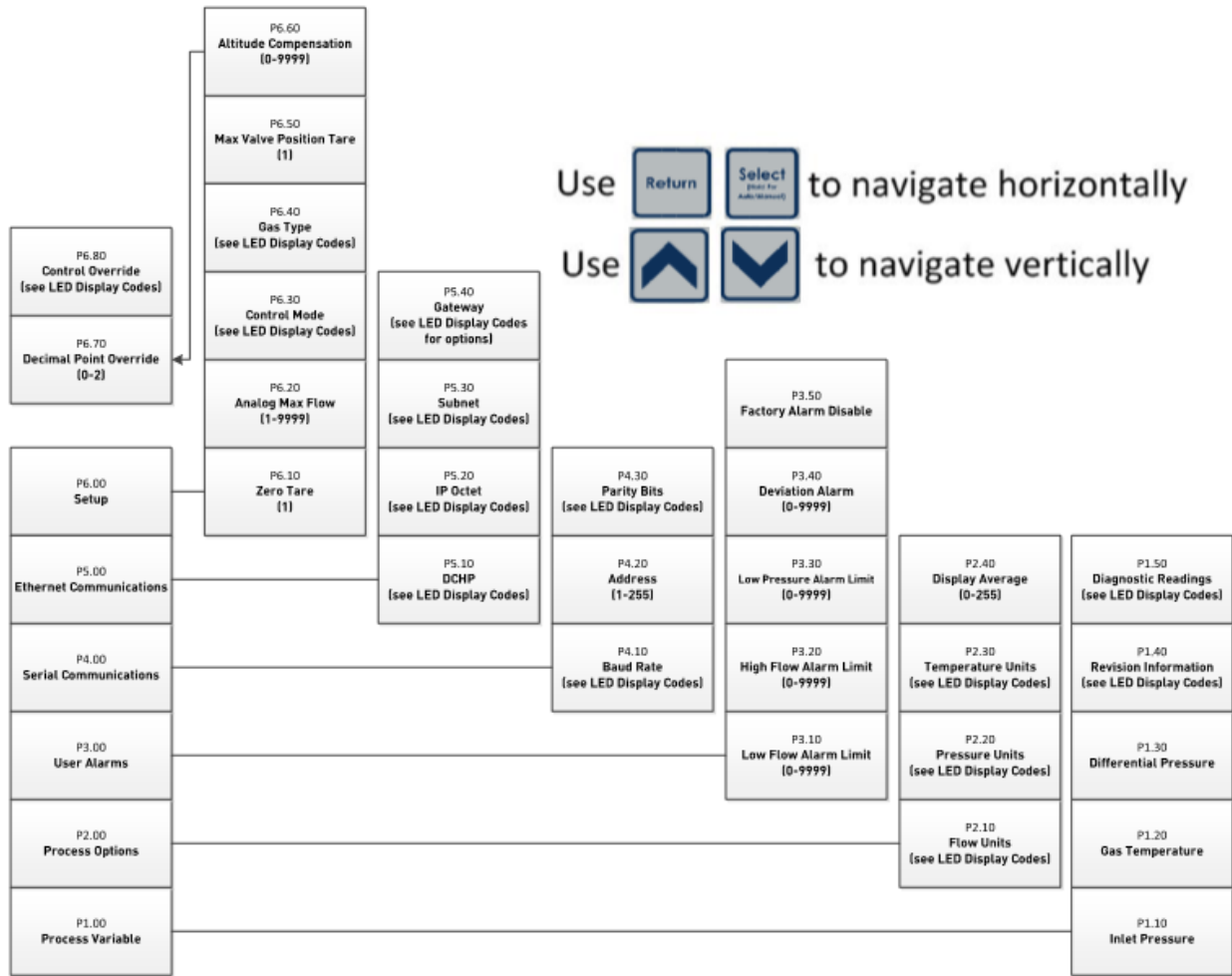

Once you have reached the desired menu option, press  to access that option. See the Keypad Menu Navigation Menu figure below for a map of the menu options. The details within each option are given in [Appendix 3](#).









Keypad Menu Navigation Menu

EXAMPLE –To access the “Low Pressure Alarm Limit” option P3.30:



- Hold  for five seconds. You will enter the menu at P 100.
- Press  twice to move (vertically) to P300
- Press  to move (horizontally) to P3.10
- Press  twice to move (vertically) to P3.30
- Press  to enter into the menu option.

Once you have entered into a menu option, use  and  to cycle through options or set values.

When ready to save the current setting or value, press .

To exit the menu option without saving changes, press .

### *Exiting the Menu System*

To exit the menu system entirely, press  to return to the 100-level menus, then press  again to return to the default eFlo display.

### Menu System Details

**P 100: Process Variable** – These values are read-only and are meant for diagnostic purposes.

- **P 110: Inlet Pressure** – Line Pressure measured by the high pressure sensor; the value is based on the unit set in **P220**.
- **P 120: Gas Temperature** – Line Temperature; the value is based on the unit set in **P230**.
- **P 130: Differential Pressure** – Difference in pressure measured between the high and low pressure sensors; the value is based on the unit set in **P220**.
- **P 140: Revision Information** – For internal use only.
- **P 150: Diagnostic Readings** – For internal use only.

**P200: Process Options** – These values are modifiable and change how the user views the flow rate and process variables.

- **P210: Flow Units** – Unit of flow rate displayed.
- **P220: Pressure Units** – Unit of pressure displayed.
- **P230: Temperature Units** – Unit of temperature displayed.
- **P240: Display Average** – Increasing this value will increase the average of the flow rate being displayed on the main screen (range for this value is 1 to 255).

**P300: User Alarms** – Values are modifiable and allow the user to set custom high and low flow alarms as well as low pressure alarms in addition to the factory low and high pressure alarms.

- **P310: Low Flow Alarm Limit** – Triggers an alarm if the flow drops below the programmed value (0 = alarm not set).
- **P320: High Flow Alarm Limit** – Triggers an alarm if the flow increases above the programmed value (0 = alarm not set).
- **P330: Low Pressure Alarm Limit** – Triggers an alarm if the supply pressure drops below the programmed value (0 = alarm not set).  
*NOTE: Factory high pressure alarm is not viewable or editable.*
- **P340: Deviation Alarm** – Triggers an alarm after 60 seconds if the flow PV deviates from the flow SP more than the defined deviation (0 = alarm not set).
- **P350: Factory Alarm Disable** – Disables three preset factory alarms given in **P351** – Under Pressure, **P352** – Valve Shut, and **P353** – Max Opening (on = alarm is disabled).

**P400: Serial Communications** – Values are modifiable and are used to set the serial communications.

- **P410: Baud Rate**
- **P420: Address**
- **P430: Parity Bits**

**P500: Ethernet Communications** – Values are modifiable and are used to set the Ethernet Settings.

- **P510: DHCP** – Enabling allows the unit to automatically obtain addressing.
- **P520: IP Octet** – Used to manually set the IP address of the device.
- **P530: Subnet** – Used to manually set the Subnet of the device.
- **P540: Gateway** – Used to manually set the Gateway of the device.

**P600: Setup** – Values are modifiable and changes important device options.

**NOTE: These options should ONLY be changed if absolutely necessary. Please contact SSi before making changes to these settings.**

- **P610: Zero Tare** – Resets the zero flow rate of the meter (manual mode with valve closed only).
- **P620: Analog Max Flow** – Sets the 4-20mA analog in and out based on desired max flow rate allowable.
- **P630: Control Mode** – Sets control method of the meter. Options include Flow mode, Valve mode, Manual mode, and Ratio mode.
  - Flow mode refers to standard control based on a specific flow setpoint for use with standard gases.
  - Valve mode refers to valve position control based on % output (commonly used for carbon control gases).
  - Manual mode is used for analog flow meters and in-line meters, which do not contain valve motors for automatic flow control.
  - Ratio mode is used for specific applications involving ratio control like mixing systems.
- **P640: Gas Type** – Used to set the gas type of the meter. **NOTE: changing this value may limit the amount of flow indicated by the info tag on the front of the meter.**
- **P650: Max Valve Position Tare** – Sets the max position the valve is capable of driving to in valve position mode (manual mode with valve opened to desired max flow rate).
- **P660: Altitude Compensation** – Sets the altitude for the installed location. Units are feet above sea level.
- **P670: Decimal Point Override** – Allows the flow to display with no, 1, or 2 decimal points.
- **P680: Control Override** – Allows temporary digital control of the meter assuming that the meter set point is being controlled with an analog signal. When set to “Auto”, the meter can be remotely controlled with a digital or analog signal. This feature is for special uses. Contact SSi for more details about this option.

Reference [Appendix 3](#) for a detailed chart of parameter options.

Touchscreen Operating Procedure

The eFlo system is equipped with a pressure and flow rate alarm (high and low), flow rate totalizer, and integrated valve control. The unit can be operated in either manual or automatic mode for flow rate control. This section of the manual also provides an explanation of the basic menu navigation through the touchscreen interface as well as how the unit operates including: valve control modes, flow limit control, flow alarming, flow totalizing, and programming of the unit.

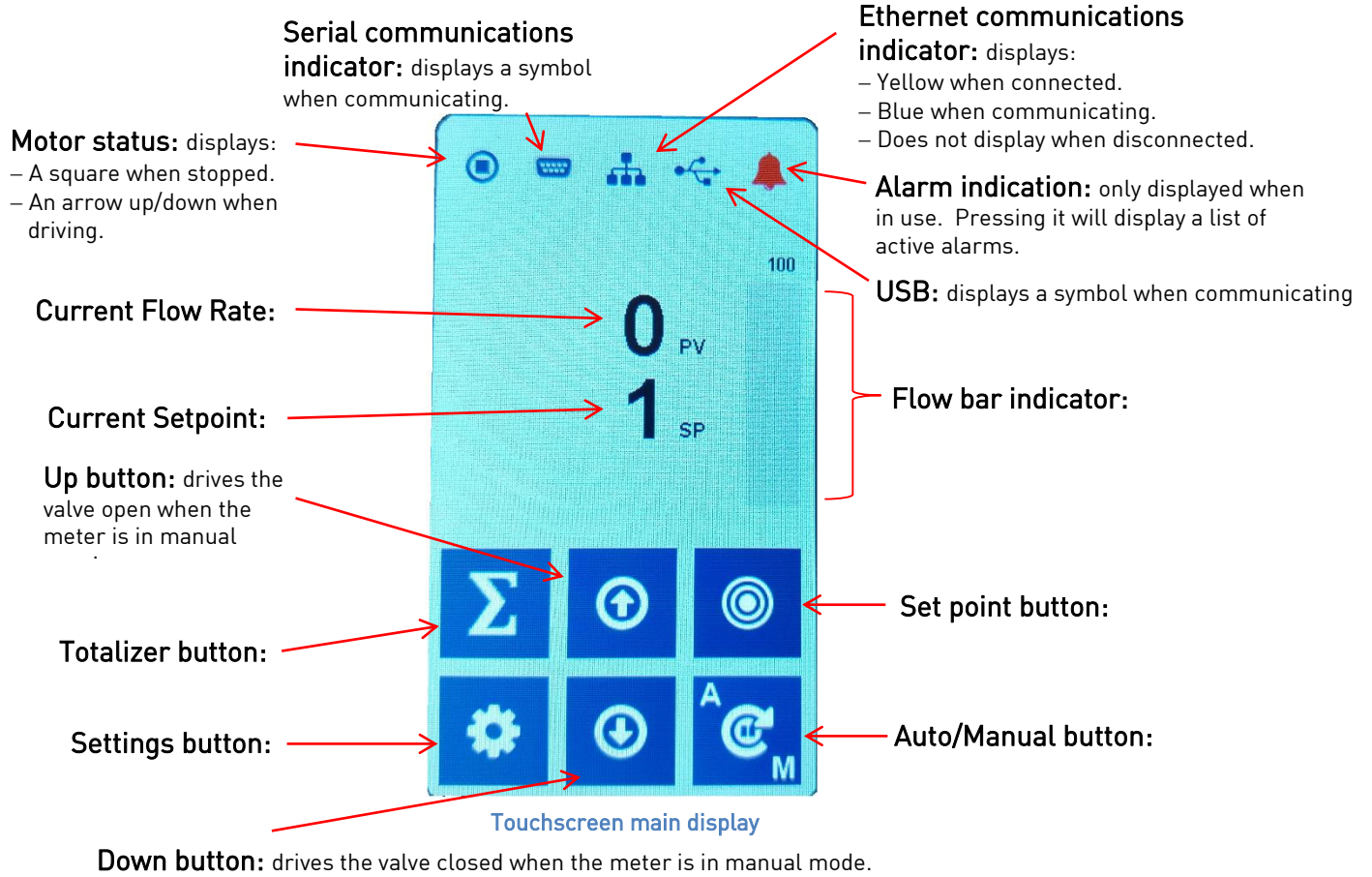

The figure below shows the layout of the Main Screen on the touchscreen eFlo 2.0 unit.



### Touchscreen Basic Functions

This section explains the most basic functionality of the eFlo 2.0. Additional options are available in the Setup menu and are explained in more detail in subsequent sections.

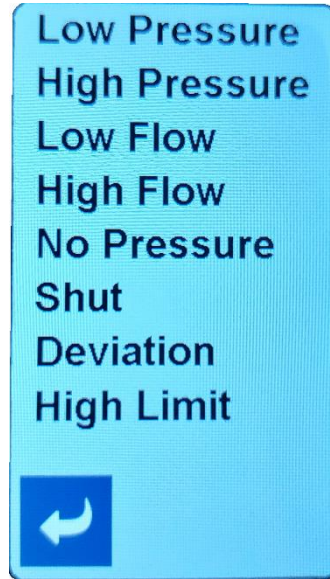

### View Active Alarms

To view the active alarms, push on the  symbol. This will bring up a list of active alarms. To return to the main screen, press .





Active Alarms Screen

### View Totalized Flow

To view totalized flow, push . This will bring up the totalizer screen. To return to the main screen, press .

### Reset Totalized Flow

To reset the totalized flow, push  from the totalizer screen. To return to the main screen, press .

The flow rate totalizer records cumulative flow rates measured by the meter. The totalizer is active at all times. The maximum totalized value is 999,999,999,999 (in any unit of flow measurement).



Totalizer Screen

### Switch between Auto and Manual Modes

To switch between Auto and Manual modes, hold  for five seconds. When in Manual mode, the screen will display a yellow background (see below).

Auto Mode  
Display

Manual Mode  
Display

In Auto mode, the motorized valve will be automatically adjusted based on setpoint.



In Manual mode, the Up and Down buttons will drive the motorized valve open and closed when pressed.

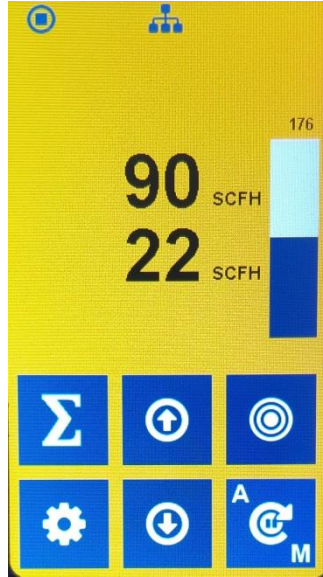



Auto and Manual Modes

*Adjust Flow Rate (Manual Mode Only)*

To adjust the flow rate while in Manual mode, use  and .

*Adjust Setpoint*

To display the current setpoint, press . This will bring up the setpoint screen.

Use the numeric keypad to enter the desired setpoint. Press  to accept changes, or press  to return to the main screen without saving changes.

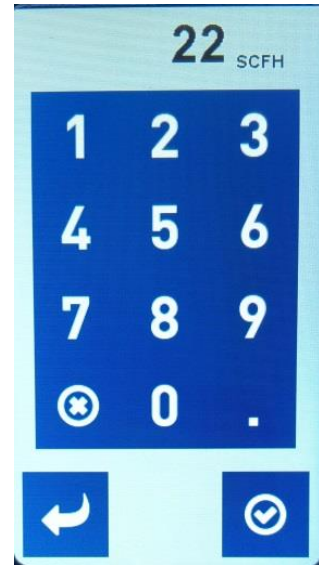

Setpoint Screen

NOTE: Setpoint can also be adjusted using one of the following methods:

1. Remote analog signal (4-20mA)
2. Remote digital signal with Modbus serial communications over RS485 – Register 18
3. Web interface (refer to Main Screen).

**Note:** The remote setpoint setting overwrites any manual setting. Therefore, if manual control of setpoint is desired, ensure that there is no external signal overwriting the manual setting.

## Settings Menu

To enter the Settings Menu, press .

The Settings Menu contains seven options including:

- Instrument Information & Diagnostics Menu
- Basic Configuration Menu
- Basic Configuration - Flow Alarm Menu
- Network Configuration - Serial Comms Menu
- Network Configuration - Ethernet Comms Menu
- Instrument Configuration - Gas Menu
- Instrument Configuration - Additional Options Menu

Details of each menu option are explained on the following pages.

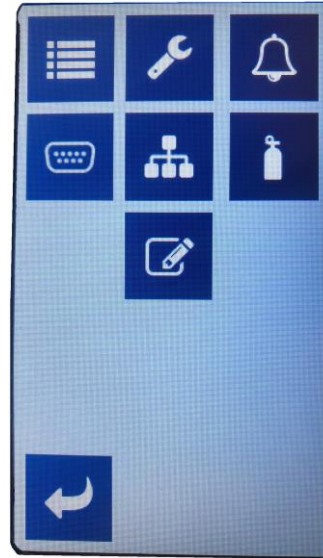

Settings Menu Screen



## Instrument Information & Diagnostics Menu

This screen displays the following information:

- Model: Instrument model.
- Serial: Instrument serial number .
- 31677/31676/31675 Version: Circuit board software version.
- Air flow: Calculated air flow from the remote analog signal when the meter is used in Ratio Mode.
- High pressure: Pressure sensor mA reading on the “high” side of the orifice plate (N/A for the eFlo-H or eFlo-L meters).
- Low pressure: Pressure sensor mA reading on the “low” side of the orifice plate.
- Analog in: Analog input mA signal being received.
- Analog out: Analog output mA signals being sent.
- Temperature: Gas/Liquid temperature flowing through the meter.
- Valve maximum tare step setting.
- Valve zero tare step setting.

Model:	eFlo 2.0
Serial:	EF220344
31677 Version:	1.09
31676 Version:	1.07
31675 Version:	1.10
Air Flow:	0.0 SCFH
High Pressure:	3.980 mA
Low Pressure:	3.996 mA
Analog In:	0.355 mA
Analog Out:	4.000 mA
Temperature:	77.9 °F
Valve Tare:	14000
Flow Tare:	2

Information & Diagnostics Menu

Press  to return to the menu screen.



### Basic Configuration Menu

These values are read-only and are meant for diagnostic purposes.

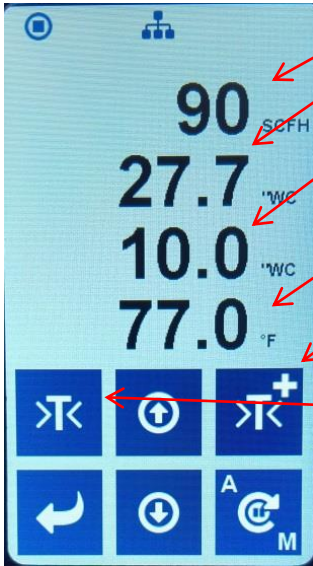

- Flow:** The current flow reading
  - Inlet Pressure:** Line Pressure measured by the high pressure sensor; the value is based on the unit set in the Units menu.
  - Differential Pressure:** Pressure measured by the high and low pressure sensors; the value is based on the unit set in the Units menu.
  - Gas Temperature:** Line Temperature; the value is based on the unit set in the Units menu.
  - Max Tare Button:** This button is used to set the max valve position. The eFlo must be in manual mode. Manually open the valve until the max flow is achieved, then press the button.
  - Zero Tare Button:** This button is used to zero the meter reading. The eFlo must be in manual mode. Manually close the valve, then press the button.
- Press  to return to the menu screen.

Process Variable Menu



### Basic Configuration - Flow Alarm Menu

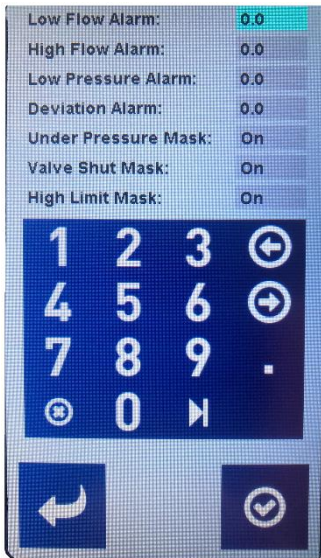

Flow Alarm Menu

- Low Flow Alarm Limit:** Triggers an alarm if the flow drops below the programmed value (0 = alarm not set).
- High Flow Alarm Limit:** Triggers an alarm if the flow increases above the programmed value (0 = alarm not set).
- Low Pressure Alarm Limit:** Triggers an alarm if the supply pressure drops below the programmed value (0 = alarm not set).
- Deviation Alarm Limit:** Triggers an alarm after 60 seconds if the flow PV deviates from the flow SP more than the defined deviation (0 = alarm not set).
- Under Pressure Mask:** Triggers an alarm when the differential pressure is less than 3" W.C. of the supply pressure (On = alarm is active).
- Valve Shut Mask:** Triggers a "Shut" display when the flow is less than 10% of the maximum flow and there is pressure available. This alarm is used mainly on manual eFlo meters and in-line meters to alert the user that the meter's valve may not be fully closed (On = alarm is active).
- High Limit Mask:** Triggers an alarm when the valve is fully opened to its maximum limit (On = alarm is active).





### Network Configuration - Serial Communications Menu

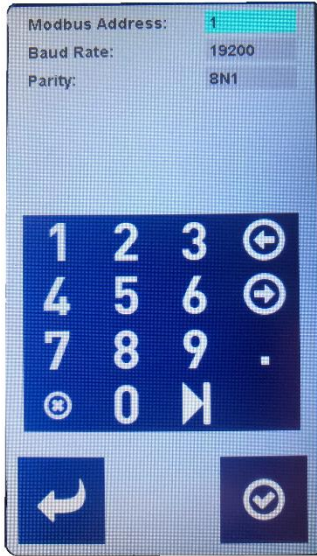

Serial Communications Menu

Values are modifiable and are used to set the serial communications. Press the button to scroll through the options and highlight each value for modification.

**Modbus Address:** Use the numeric keypad to input the desired settings.

**Baud Rate:** Used to select the desired Baud Rate. Tap to select.

**Parity:** Used to select the desired Parity.

Press to accept changes, or press to return to the menu screen without saving changes.



### Network Configuration - Ethernet Communications Menu

By default, this menu is passcode-protected. Use the numeric keypad to enter the appropriate security code.

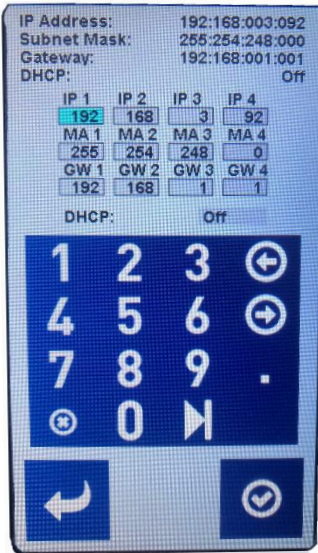

Ethernet Communications Menu

Values are modifiable and are used to set the Ethernet Settings.

Use the numeric keypad to input the desired settings.

**IP 1-4:** Used to manually set the IP address of the device.

**MA 1-4:** Used to manually set the Subnet mask of the device.

**GW 1-4:** Used to manually set the Gateway of the device.

**DHCP:** Enabling allows the unit to automatically obtain addressing.

Use the button to advance/scroll through each setting. Use to clear the current selection and use the keypad to enter a new setting.

Press to accept changes, or press to return to the menu screen without saving changes.



### Instrument Configuration - Gas Menu

By default, this menu is passcode-protected. Use the numeric keypad to enter the appropriate security code.

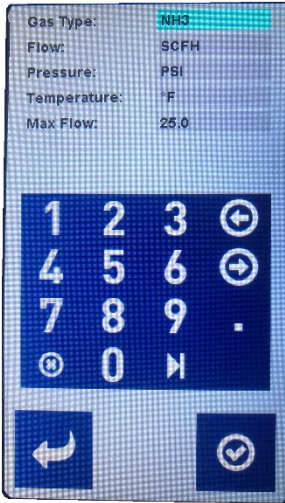

Gas Menu

Use the button to advance/scroll through each setting. Use the or buttons to scroll through the list of programmed settings.

Tap the desired gas type. Press to accept changes, or press to return to the menu screen without saving changes.

**NOTE:** changing this value may limit the amount of flow indicated by the info tag on the front of the meter

**This option should ONLY be changed if absolutely necessary. Please contact SSi before making changes to this setting.**



### Instrument Configuration – Addition Options Menu

These settings affect how flow changes are displayed. They also affect how the meter controls flow from an external control source.

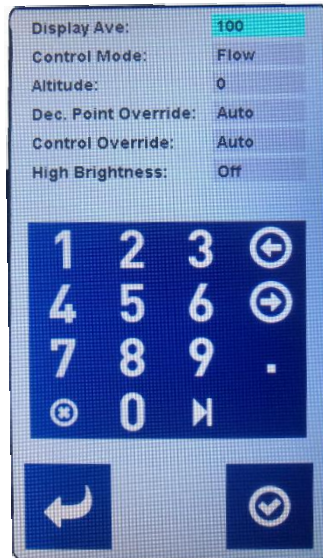

Instrument Configuration

**Display Ave:** This value acts like a filter by averaging the flow values, which are displayed. The setting is in tenths of a second (i.e. 100 = 10.0 seconds). This only affects how the flow is displayed and not how the meter controls the flow.



**Control Mode:** The control mode affects how the meter is controlled by an external source.



- Flow mode refers to standar control based on a specific flow set point for use with standard gases.
- Valve mode refers to valve position control based on % output for carbon control gases.
- Manual mode is used on meters with no valve motor for automatic adjustment. This includes the eFlo manual meter (with a control knob) and the eFlo In-line meter.
- Ratio mode is used for specific applications involving ratio control like mixing systems.

**Altitude:** –This is the altitude in feet above sea level where the meter is installed and operating. This value affects the flow due to changes in air density at a given altitude.

**Dec. Point Override:** This setting allows the flow to be displayed with a given number of decimal point places. It is limited to 2 decimal points.

**Control Override:** In Auto mode the system gives priority to the analog signal. The override is used to set a digital signal even though an analog signal is present.

Use the  button to advance/scroll through each setting. Use the  or  buttons to scroll through the list of programmed settings.

Tap the desired gas type. Press  to accept changes, or press  to return to the menu screen without saving changes.

## Maintenance

There is no routine maintenance required for the eFlo 2.0 unit. Please contact SSi with any questions not covered in the Troubleshooting Guide.

## Web Interface

The eFlo meter is equipped with a web interface that can be accessed using an Internet web browser such as Mozilla Firefox, Google Chrome, or Microsoft Internet Explorer. In order to open the web interface with a web browser, you will need to know either the IP address or the hostname of the web interface. SSi recommends asking an IT engineer or network administrator to set up the web interface prior to use.

### Using the Web Interface

To access the web interface, open a web browser, and in the location bar, enter the IP address or name of the webserver. The main screen will then appear, as shown in **Error! Reference source not found.**

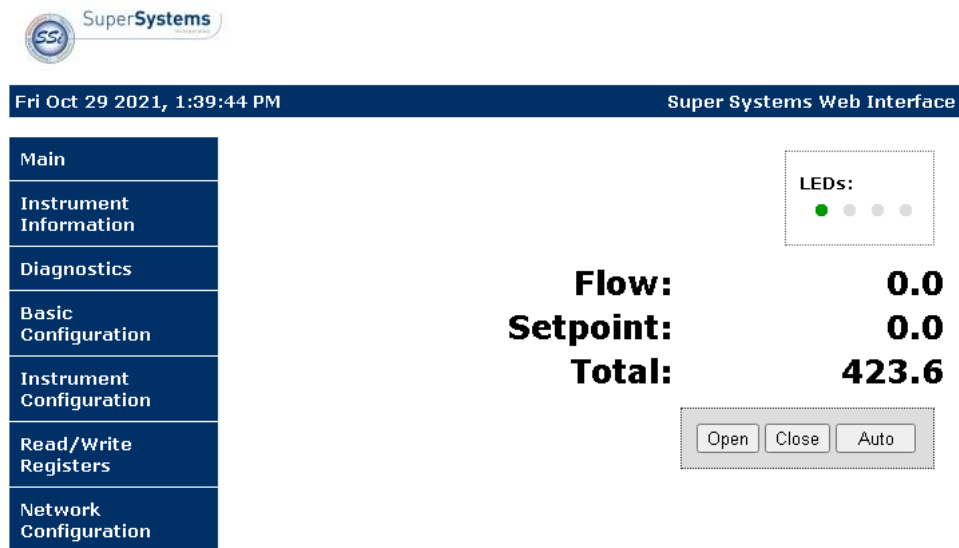

SuperSystems

Fri Oct 29 2021, 1:39:44 PM Super Systems Web Interface

Main  
Instrument Information  
Diagnostics  
Basic Configuration  
Instrument Configuration  
Read/Write Registers  
Network Configuration

LEDs:  
● ● ●

**Flow: 0.0**  
**Setpoint: 0.0**  
**Total: 423.6**

Open Close Auto

Copyright © 2017 Super Systems, Inc.

Main Screen of Web Interface

The web interface features several screens. Note that some screens require a login and password. The default login is username **admin** with password **2** (unless otherwise specified by the customer at the time of order).

- **Main.** This screen shows status information such as flow rate, setpoint, and which LEDs are illuminated on the unit, and the amount of total flow since the previous reset.
- **Instrument Information.** This screen shows eFlo model number, unit serial number, and software version number.
- **Diagnostics.** This screen displays information on pressure differential, inlet pressure, temperature, and density.
- **Basic Configuration.** The Basic Configuration screen displays, and allows you to change, basic operating parameters for the eFlo unit.
- **Instrument Configuration** (login and password required). The Instrument Configuration screen displays, and allows you to change, operating parameters for the eFlo unit.
- **Read/Write Registers** (login and password required). This screen displays the register values of the meter for setup and troubleshooting purposes.
- **Network Configuration** (login and password required). Using this screen, you can adjust network settings, such as host name and IP address. Note that if DHCP is enabled, the IP address will be dynamic allowing the network to assign the address.

#### *Main Screen*

The main screen (shown above) provides real-time information on the operation of the eFlo unit. The current gas flow process value and setpoint are displayed, as well as the totalized flow. Four circular icons on the screen represent the four LEDs on the front of the unit; these icons will illuminate and darken along with the corresponding LEDs. The **Open** button will drive the motor to open the valve, and the **Close** button will drive the motor to close the valve.

#### *Instrument Information*

The Instrument Information page displays the SSi model number, specific serial number of the eFlo unit, and the current version of the software.

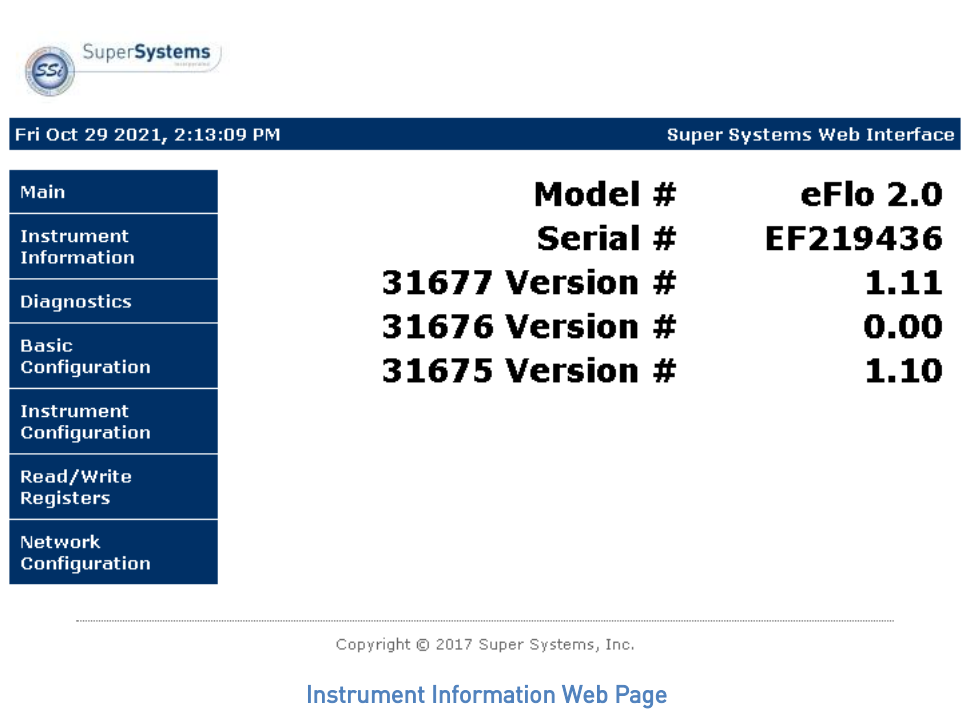

The screenshot shows the Super Systems Web Interface. At the top left is the SuperSystems logo. Below it, a dark blue header bar contains the date and time 'Fri Oct 29 2021, 2:13:09 PM' on the left and 'Super Systems Web Interface' on the right. A vertical navigation menu on the left side lists: Main, Instrument Information, Diagnostics, Basic Configuration, Instrument Configuration, Read/Write Registers, and Network Configuration. The main content area displays the following information:

<b>Model #</b>	<b>eFlo 2.0</b>
<b>Serial #</b>	<b>EF219436</b>
<b>31677 Version #</b>	<b>1.11</b>
<b>31676 Version #</b>	<b>0.00</b>
<b>31675 Version #</b>	<b>1.10</b>

At the bottom of the page, there is a copyright notice: 'Copyright © 2017 Super Systems, Inc.' and a blue link labeled 'Instrument Information Web Page'.

*Diagnostics*

This screen displays information on pressure differential, inlet pressure, temperature, and density. It also provides the mA readings of the differential pressure transducer.

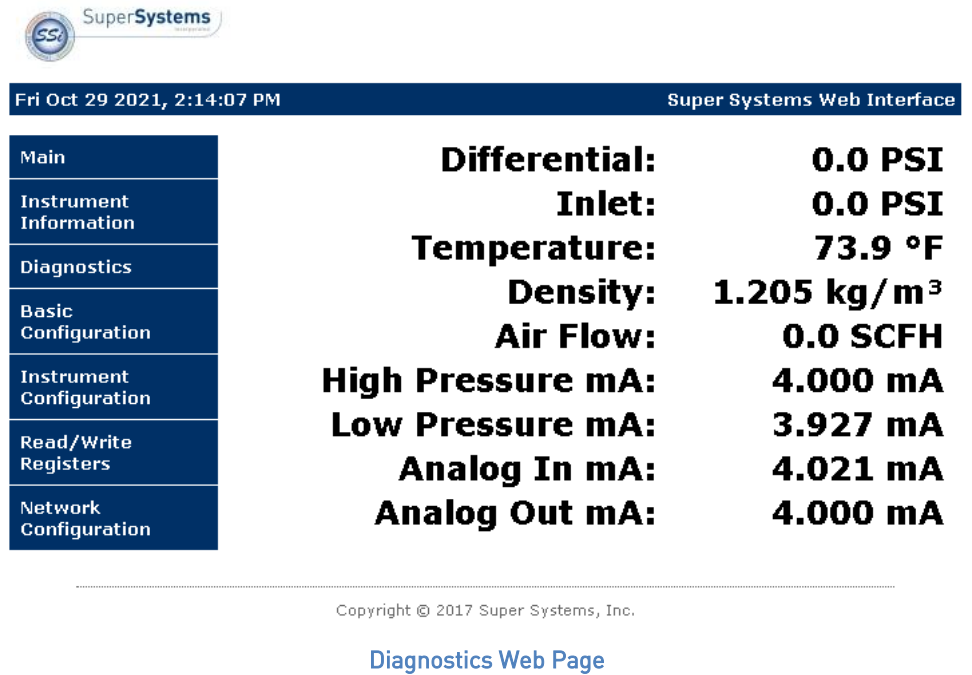

The screenshot shows the Super Systems Web Interface. At the top left is the SuperSystems logo. Below it, a dark blue header bar contains the date and time 'Fri Oct 29 2021, 2:14:07 PM' on the left and 'Super Systems Web Interface' on the right. A vertical navigation menu on the left side lists: Main, Instrument Information, Diagnostics, Basic Configuration, Instrument Configuration, Read/Write Registers, and Network Configuration. The main content area displays the following diagnostic information:

<b>Differential:</b>	<b>0.0 PSI</b>
<b>Inlet:</b>	<b>0.0 PSI</b>
<b>Temperature:</b>	<b>73.9 °F</b>
<b>Density:</b>	<b>1.205 kg/m<sup>3</sup></b>
<b>Air Flow:</b>	<b>0.0 SCFH</b>
<b>High Pressure mA:</b>	<b>4.000 mA</b>
<b>Low Pressure mA:</b>	<b>3.927 mA</b>
<b>Analog In mA:</b>	<b>4.021 mA</b>
<b>Analog Out mA:</b>	<b>4.000 mA</b>

At the bottom of the page, there is a copyright notice: 'Copyright © 2017 Super Systems, Inc.' and a blue link labeled 'Diagnostics Web Page'.

*Basic Configuration*

The Basic Configuration page displays current basic parameter values and provides the ability to set, select, and reset values. The parameters are described in more detail below.



Fri Oct 29 2021, 1:58:04 PM Super Systems Web Interface

Main	Instrument Information	Diagnostics	Basic Configuration	Instrument Configuration	Read/Write Registers	Network Configuration
------	------------------------	-------------	---------------------	--------------------------	----------------------	-----------------------

Field	Input	Submit	Current
Set Date/Time		Set Val	
Setpoint	0.0	Set Val	0.0
Address	24	Set Val	24
Baud Rate	19.2k	Select	19.2k
Parity Bits	8N1	Select	8N1
Reset Total		Reset	
Zero Tare	-157	Tare	1
Max Tare	140	Max Tare	3082
Low Flow Alarm	0.0	Set Val	0.0
High Flow Alarm	0.0	Set Val	0.0
Low Pres Alarm	0.0	Set Val	0.0
Deviation Alarm	0.0	Set Val	0.0
Under Pressure Alarm		Toggle	On
Valve Shut Alarm		Toggle	On
Max Opening Alarm		Toggle	On

Copyright © 2017 Super Systems, Inc.

[Basic Configuration Web Page](#)

Parameter	Description
Set Dat/Time	Sets the date/time (real time calendar clock).
Setpoint	The current flow setpoint.
Address	The Modbus address of the device - a number from 1-247. The device will respond to 250 universally.
Baud Rate	The baud rate for communications.
Reset Total	Resets the totalized value.
Zero Tare	Resets the zero flow rate of the meter.
Max Tare	Sets the maximum opening position to which the valve is capable of driving.
Low Flow Alarm	Triggers an alarm if the flow drops below the programmed value (0 = alarm not set).
High Flow Alarm	Triggers an alarm if the flow increases above the programmed value (0 = alarm not set).
Low Pres Alarm	Triggers an alarm if the supply pressure drops below the programmed value (0 = alarm not set).
Deviation Alarm	Triggers an alarm after 60 seconds if the flow PV deviates from the flow SP more than the defined deviation (0 = alarm not set).
Under Pressure Alarm**	Triggers an alarm when the differential pressure is less than 3" W.C. of the supply pressure (On = alarm is active). <b>**Not available with a standard eFlo-H or eFlo-L meter.</b>
Valve Shut Alarm	Triggers a "Shut" display when the flow is less than 10% of the maximum flow and there is pressure available. This alarm is used mainly on manual eFlo meters and in-line

	meters to alert the user that the meter’s valve may not be fully closed (On = alarm is active).
Max Opening Alarm	Indicates when the valve is opened to its maximum limit (On = alarm is active)

Parameters and Descriptions for Basic Configuration

### Instrument Configuration

The Instrument Configuration page displays current parameter values and provides the ability to set, select, and reset values. The parameters are described in more detail below.

SuperSystems

Fri Oct 29 2021, 2:03:48 PM Super Systems Web Interface

Field	Input	Submit	Current
Gas Type	Air	Select	Air
Flow Units	SCFH	Select	SCFH
Pres. Units	PSI	Select	PSI
Temp. Units	°F	Select	°F
Sensor Ave.	100	Set Val	100
Max Flow	20.0	Set Val	20.0
Ctrl Mode	Flow	Select	Flow
Serial	EF219436	Set Val	EF219436
Alt. Comp.	0	Set Val	0
Dec. Over.	Auto	Set Val	Auto
Ctrl Over.	Analog	Set Val	Analog

Copyright © 2017 Super Systems, Inc.

### Instrument Configuration Web Page

Parameter	Description
Gas Type	Used to set the gas type of the meter <i>NOTE: changing this value may limit the amount of flow indicated by the info tag on the front of the meter</i>
Flow Units	Unit of Flow Rate displayed

Pres. Units	Unit of Pressure displayed
Temp. Units	Unit of Temperature displayed
Sensor Ave.	Increasing this value will increase the average of the flow rate being displayed on the main screen (range for this value is 1 to 255)
Max Flow	Sets the 4-20mA analog in and out based on desired max flow rate allowable
Ctrl Mode	Sets the control mode between flow rate and valve position
Serial	Assigned serial number for this meter.
Alt. Comp.	Sets the altitude for the installed location. Units are feet above sea level.
Dec. Over.	Forces a meter to show more or less decimal places than are automatically set.
Ctrl Over.	Assigns the control type for setting the meter's flow set point.

Parameters and Descriptions for Instrument Configuration

*Read/Write Registers*

This screen displays the register values of the meter for setup and troubleshooting purposes.

The screenshot shows the Super Systems Web Interface. At the top left is the SuperSystems logo. The header displays "Fri Oct 29 2021, 2:09:18 PM" and "Super Systems Web Interface". A navigation menu on the left lists: Main, Instrument Information, Diagnostics, Basic Configuration, Instrument Configuration, Read/Write Registers (highlighted), and Network Configuration. The main content area features a table of register values:

0	1	2	3	4
111	0	29830	16	0
5	6	7	8	9
2	2144	0	0	0

Below the table is a configuration section with the following fields:

Field	Input	Submit	Current
Read Offset	<input type="text" value="0"/>	Set Val	0
Write Offset	<input type="text" value="0"/>	Set Val	0
Write Number Regs	<input type="text" value="0"/>	Set Val	0
Submit Write	<input type="button" value="Submit"/>		

At the bottom of the configuration section, there are two rows of five input fields each, all containing the value "0".

Copyright © 2017 Super Systems, Inc.

[Read/Write Registers Web Page](#)

*Network Configuration*

Using this screen, you can adjust network settings, such as host name and IP address.



The screenshot shows the Super Systems Web Interface. At the top left is the SuperSystems logo. The top bar displays the date and time 'Fri Oct 29 2021, 2:16:57 PM' and the page title 'Super Systems Web Interface'. A navigation menu on the left lists: Main, Instrument Information, Diagnostics, Basic Configuration, Instrument Configuration, Read/Write Registers, and Network Configuration. The main content area is titled 'Interface Configuration' and contains the following text: 'This page allows the configuration of the board's network settings.' Below this is a red 'CAUTION' box: 'CAUTION: Incorrect settings may cause the board to lose network connectivity. Recovery options will be provided on the next page.' The text 'Enter the new settings for the network interface below:' is followed by a form with the following fields: 'IP Address:' (192.168.2.58), 'Gateway:' (192.168.1.1), and 'Subnet Mask:' (255.255.248.0). There is an unchecked 'Enable DHCP' checkbox and a 'Save Settings' button.

Copyright © 2017 Super Systems, Inc.

#### [Interface Configuration Web Page](#)

The Interface Configuration page allows you to view network settings and change certain settings as well. **SSi recommends consulting an IT engineer or network administrator before changing any of these settings.**

To enable dynamic assignment of IP addresses, click on the **Enable DHCP** checkbox. Dynamic assignment means that the eFlo unit's IP address on the network will be assigned automatically, preventing IP address conflicts. The network must support dynamic IP assignment in order for this to work.

If Enable DHCP is not checked, IP and other settings can be changed manually. **These settings should be verified with your network administrator before being changed.** Failure to do so could result in IP conflicts and other network issues.

**Alarms**

<b>Alarm Code</b>	<b>Possible Causes</b>	<b>Possible Corrective Actions</b>
<b>h iPr</b> (High Pressure Factory Alarm)	Inlet pressure is above the max inlet pressure for the meter.	Decrease regulator pressure below the usable range of the sensor indicated on the calibration certificate.
<b>unPr</b> (Under Pressure Factory Alarm)	Due to low pressure based on factory-specified values, meter is unable to reach setpoint. Alarm is only active in Flow Control Mode with a setpoint above 0.	Increase regulator pressure. Verify all upstream solenoids and/or ball valves are open.
<b>shut</b> (Shut Factory Alarm)	Flow rate is below accuracy threshold of 10:1. Alarm is only active in manual meters. This is a warning that flow rate accuracy is not guaranteed.	If a zero flow is required, make sure the knob is fully shut, as a false zero could be displayed.
<b>h iLn</b> (Hi Limit Factory Alarm)	Valve has achieved maximum allowable position.	Perform a Max Tare at desired valve position. Verify inlet pressure is high enough to reach setpoint or desired flow rate.

Alarms

If you experience problems and cannot find the solution after troubleshooting, please call SSI Technical Support at (513) 772-0060.

Troubleshooting

**WARNING!**

When troubleshooting, follow all proper safety precautions. Use proper eye protection and hand protection at all times.

Problem	Possible Causes	Possible Corrective Actions
Unit is not reaching higher flow setpoint	Pressure may be less than pressure specified on order  Meter may not be the correct size  Meter may not be calibrated for correct gas  Gas piping may be too small for required flow	Adjust regulator using a manometer to set correct pressure while gas is flowing and meter is open  Call SSi at (513) 772-0060 to discuss a different size (model) of flow meter  Verify Calibration Report for gas calibration. If the gas is different than the gas you are flowing through the meter, contact SSi at (513) 772-0060 to discuss a recalibration.  Verify that the plumbing is adequate for the maximum flow required through the meter.
Unit is indicating that there is gas flow when no flow should be present	Zero value is not set on the meter (if gas supply is shut off)  The shutoff valve may be located upstream of the flow meter. This causes a zero drift condition since there is no pressure on the meter.	Verify that the hand valve for gas supply is closed. If flow is still showing, perform the zero calibration procedure as shown in the manual.  <ul style="list-style-type: none"> <li>• SSi recommends that the shutoff valve be moved downstream of the meter so that gas pressure on the meter is always available. The error will correct itself when gas pressure is supplied to the meter.</li> <li>• Another option is to perform a Zero Calibration. See the Zero Adjustment &amp; Calibration section on page 14 for more details.</li> </ul>

eFlo-H & eFlo-L Electronic High Pressure Flow Meter Operations Manual

Problem	Possible Causes	Possible Corrective Actions
Unit is indicating that there is no gas flow when calling for a flow setpoint	Hand valve for gas supply may be closed  If a solenoid is used, solenoid may not be energized  Restrictions may be present downstream in the gas supply	Open hand valve.  Ensure that solenoid is energized.  Check for issues such as exhaust gas outlet restriction, and correct any problems.
Unit indicates that pressure is dropping as flow increases.	Insufficient gas flow to maintain constant pressure.	Verify that there is sufficient gas supply to the meter to maintain a constant pressure
Unit is not communicating	Communications may not be configured correctly	Verify RS485 wire polarity  Verify address and baud rate  Verify that only one meter has address set to 1 on the RS485 loop
Unit is not reaching setpoint	There may be insufficient gain  Insufficient pressure may be supplied	Verify gain is high enough; adjust bias as needed  Adjust the pressure to the pressure indicated on the meter and the Calibration Report. Verify the pressure at the high pressure port.
Setpoint cannot be changed directly from the eFlo control panel	An analog setpoint signal may be wired and overwriting manual setpoint  A master device wired to the eFlo may be overwriting manual setpoint	Ensure that an analog input signal to the eFlo is not wired and overwriting manual setpoint  Ensure that no device is actively writing the setpoint via communications

**Troubleshooting**

If you experience problems and cannot find the solution after troubleshooting, please call SSi Technical Support at (513) 772-0060.

## Warranty

### *Limited Warranty for Super Systems Products:*

The Limited Warranty applies to new Super Systems Inc. (SSI) products purchased direct from SSI or from an authorized SSI dealer by the original purchaser for normal use. SSI warrants that a covered product is free from defects in materials and workmanship, with the exceptions stated below.

The limited warranty does not cover damage resulting from commercial use, misuse, accident, modification or alteration to hardware or software, tampering, unsuitable physical or operating environment beyond product specifications, improper maintenance, or failure caused by a product for which SSI is not responsible. There is no warranty of uninterrupted or error-free operation. There is no warranty for loss of data—you must regularly back up the data stored on your product to a separate storage product. There is no warranty for product with removed or altered identification labels. SSI DOES NOT PROVIDE ANY OTHER WARRANTIES OF ANY KIND, INCLUDING, BUT NOT LIMITED TO, THE IMPLIED WARRANTIES OR CONDITIONS OF MERCHANTABILITY AND FITNESS FOR A PARTICULAR PURPOSE. SOME JURISDICTIONS DO NOT ALLOW THE LIMITATION OF IMPLIED WARRANTIES, SO THIS LIMITATION MAY NOT APPLY TO YOU. SSI is not responsible for returning to you product which is not covered by this limited warranty.

If you are having trouble with a product, before seeking limited warranty service, first follow the troubleshooting procedures that SSI or your authorized SSI dealer provides.

SSI will replace the PRODUCT with a functionally equivalent replacement product, transportation prepaid after PRODUCT has been returned to SSI for testing and evaluation. SSI may replace your product with a product that was previously used, repaired and tested to meet SSI specifications. You receive title to the replaced product at delivery to carrier at SSI shipping point. You are responsible for importation of the replaced product, if applicable. SSI will not return the original product to you; therefore, you are responsible for moving data to another media before returning to SSI, if applicable. Data Recovery is not covered under this warranty and is not part of the warranty returns process. SSI warrants that the replaced products are covered for the remainder of the original product warranty or 90 days, whichever is greater.

Revision History

Rev.	Description	Date	MCO #
-	First release (replaces 4639 eFlo L/H)	4-26-2022	2323

Appendix 1: Overall Dimensions of Assembled Meter

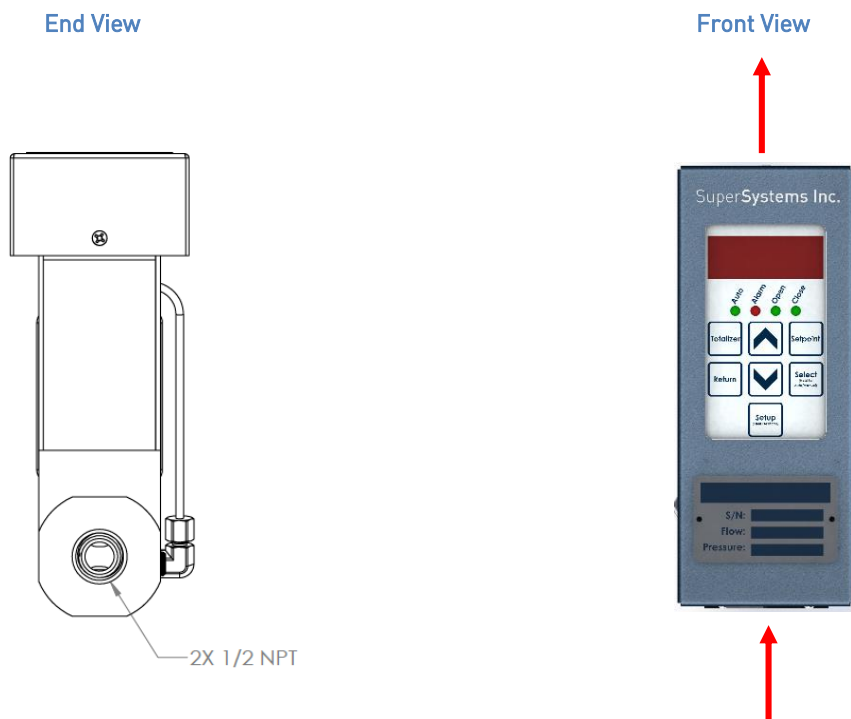
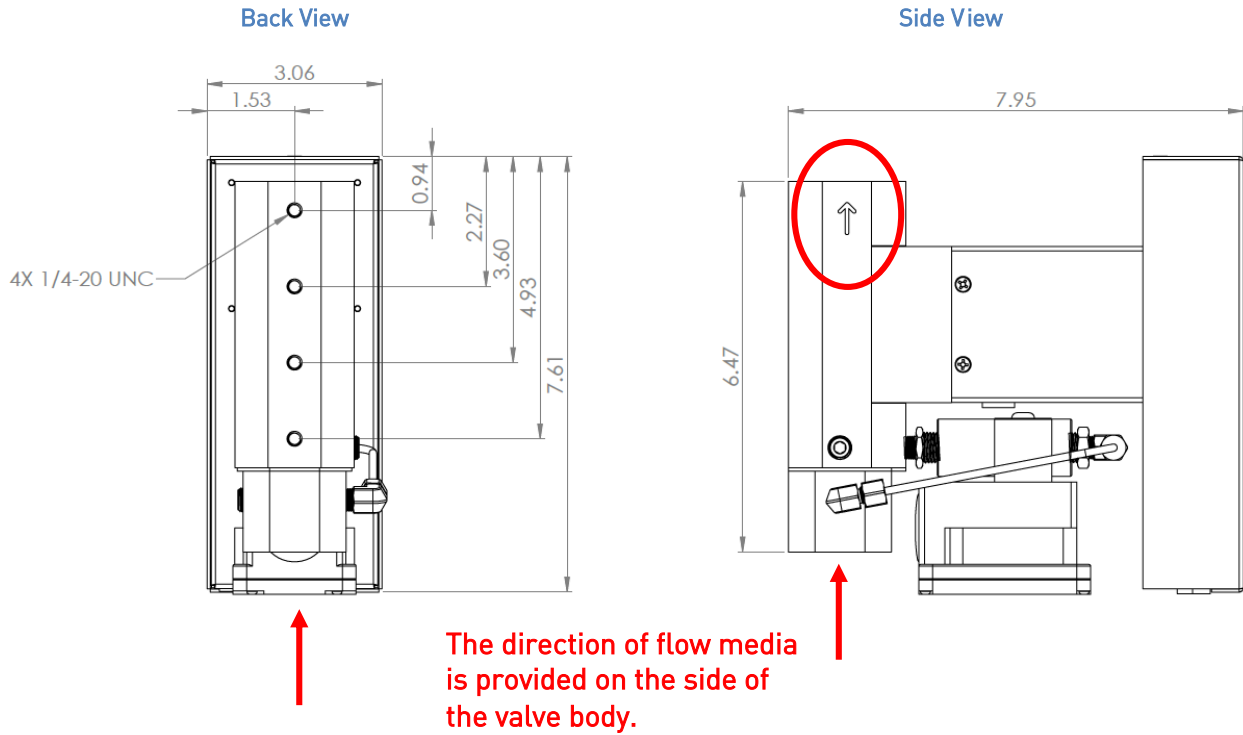

## Appendix 2: Zero Tare & Zero Calibration Procedures

### Zero Tare:

Milliamp reading is greater than 3.75 mA and less than 4.25 mA

**Zero Tare** involves changing the zero offset in the electronics to account for the pressure applied to the inlet at zero gas flow. After shipping and installation, the differential pressure transducer often requires a **Zero Tare** because the transducer is very sensitive to its position with respect to gravity. Once the meter is installed in its final position, it should be stable and not require additional **Zero Tare** procedures.





For optimal accuracy and control, the following procedure is recommended:

LED with keypad model:

1. **Zero Tare** (Resets the zero flow rate of the meter)
  - a. With the meter in manual mode and supply gas/liquid pressure applied to the meter, drive the valve completely closed.
  - b. Enter the setup menu and enter **P6.10**
  - c. Change the value to 1 and press Select to save.
2. **Max Tare** (Sets the max position the valve can drive to in valve position mode)
  - a. With the meter in manual mode, drive the valve open to the desired max flow rate.
  - b. Enter the setup menu and enter **P6.50**
  - c. Change the value to 1 and press Select to save.
3. **Altitude Compensation**
  - a. Enter the setup menu and enter **P6.60**
  - b. Enter the actual altitude for the installed location.
  - c. Press Select to save.

Touchscreen model:



Touchscreen model:

1. **Zero Tare** (Resets the zero flow rate of the meter)
  - a. With the meter in manual mode and supply gas/liquid pressure applied to the meter, drive the valve completely closed.
  - b. From the main screen, enter the setup menu  and push the zero tare  button.
  - c. This will zero the meter and the flow should adjust to zero accordingly.
2. **Max Tare** (Sets the max position the valve can drive to in valve position mode)
  - a. With the meter in manual mode and supply gas/liquid pressure applied to the meter, drive the valve open to the desired max flow rate.
  - b. From the main screen, enter the setup menu  and push the max tare  button.



- c. This will set the current position of the valve to be the maximum position allowed during normal operation.

### 3. Altitude Compensation

- a. From the main screen, enter the Setup menu  and Instrument Configuration - Additional Options menu .
- b. Enter the actual altitude for the installed location.
- c. Press Select to save.

#### Zero Calibration:

Milliamp reading is less than 3.75 or greater than 4.25 mA.

When the mA reading is greater than 4.25mA or less than 3.75mA with pressure applied and the valve closed, a **Zero calibration** is recommended. This requires a physical adjustment to the transducer zero screw terminal. The procedure is as follows:

1. Install the meter in the final location and position in which it will be used. This will help reduce any additional drift in the mA reading.
2. Apply power to the meter and use the web interface or eFlo user interface to display the mA reading.
3. Manually drive the valve completely closed.
4. Verify that the supply pressure is applied to the meter.
5. Remove the cover of the pressure transducer. It is held on by four (4) Phillips head screws.

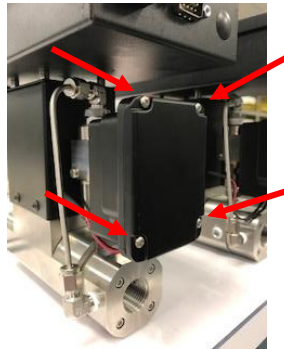

eFlo Pressure Transducer Cover

6. You will see two wires (one red and one black wire) attached to two terminals. Just under those terminals are two access screws. One is labeled "ZERO" and the other is labeled "SPAN." Remove the ZERO access screw only. **Do not adjust the SPAN on the pressure transducer.**

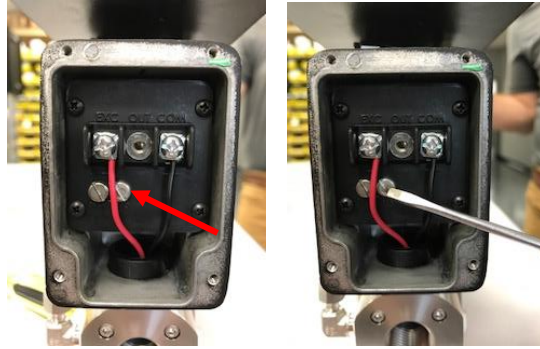

Pressure Transducer ZERO Access Screw

7. This access port allows access to the ZERO screw on the circuit board of the transducer. Using a small flat screwdriver, adjust the ZERO screw and watch the change in the mA reading. Only a slight adjustment to the screw will result in a significant mA change.

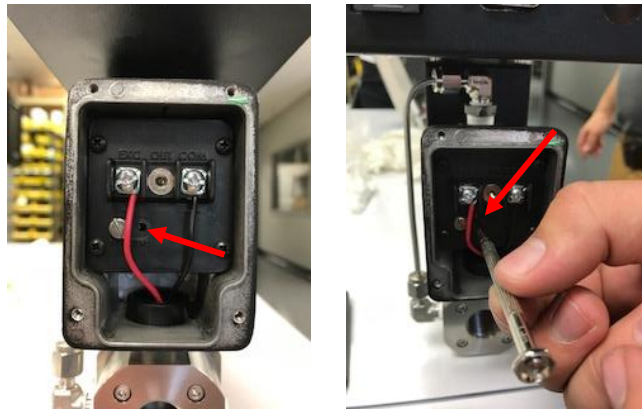

Pressure Transducer ZERO Adjustment Screw

8. When the mA reading is adjusted properly, replace the ZERO access screw and the cover on the transducer to prevent dust and/or liquid from entering the electronics of the transducer.

The transducer should now be ready for a **Zero tare**. Always perform a **Zero tare** after a **Zero calibration** is completed.

Appendix 3: Menu Option Tables

Flow Units	cFh	CFH
	m <sup>3</sup> h	m <sup>3</sup> /h
	lPh	l/hr
	gPh	gph
	cFm	CFM
	m <sup>3</sup> min	m <sup>3</sup> /min
	lPm	l/min
	gPm	gpm
	lbh	lb/h
	kg/h	kg/h

Pressure Units	inH <sub>2</sub> O	inH <sub>2</sub> O
	PSI	PSI
	OSI	OSI
	mBar	mBar
	kPa	kPa
	mmH <sub>2</sub> O	mmH <sub>2</sub> O

DHCP	dhcP	On
	nA n	Off

Parity	8n1	8N1
	8E1	8E1
	8n2	8N2

P521 - P524	P531 - P534	P541 - P544
Assigns IP Address	Assigns Subnet	Assigns Gateway

Gas Type	c2h2	Acetylene
	Air	Air
	nh3	Ammonia
	Ar	Argon
	co2	Carbon Dioxide
	co	Carbon Monoxide
	dA	Dissociated Ammonia
	Endn	Endo (w/methane)
	Endp	Endo (w/propane)
	He	Helium
	h2	Hydrogen
	ch4	Methane
	n2	Natural Gas
	n2o	Nitrogen
	o2	Nitrous Oxide
o2	Oxygen	
c3h8	Propane	
c3h6	Propylene	
h2O	Water	
MEoh	Methanol	

Ctrl Mode	0	Flow Control
	1	Valve Position
	2	Manual
	3	Ratio

Baud Rate	1200	1200
	2400	2400
	4800	4800
	9600	9600
	144	14400
	192	19200
	288	28800
	384	38400
	576	57600
	768	76800
115	115200	

Rev. Info	P141	Comm Board Revision
	P142	Control Board Revision

Diagnostics	P151	Hi Pressure Sensor mA
	P152	Lo Pressure Sensor mA
	P153	Analog Input mA
	P154	Analog Output mA
	P155	Zero Tare Value
	P156	Max Valve Position

Alarm Disable	P351	Under Pressure
	P352	Shut
	P353	Hi Limit

Ctrl Override	AnLG	Analog
	dLG	Digital

## Appendix 4: Calibration Verification Procedure

The following procedure is used for calibration of flow rate for the purpose of eFlo certification.

### IMPORTANT!

To ensure consistency and quality, it is recommended that this procedure be performed by SSI personnel. SSI takes no responsibility for calibrations performed by non-SSI personnel. If you have any questions, please contact SSI at (513) 772-0060.

For this procedure, you will need a calibrated manometer capable of being exposed to the supply pressure at which the meter is being used, a 3/16" allen wrench, two 1/8" NPT threaded fittings to which you can connect the manometer, and the original Calibration Report for the eFlo unit.

1. On the left side and right side of the main body of the flow meter, you will notice two threaded plugs. One is a high pressure port and the other is a low pressure port used for calibration. The high and low pressure ports are shown in the figure below.
2. **CAUTION:** Remove the pressure from the meter by closing the supply gas/liquid main shut-off valve. Manually open the control valve on the flow meter to release the pressure from the meter. Additional valves may need to be opened to release pressure as well. Do NOT attempt to loosen the plugs if the pressure in the meter cannot be verified.
3. Using the 3/16" allen wrench, remove the two plugs on each side of the flow meter main body (figure below). Install the two 1/8" NPT threaded fittings that will be used to connect the manometer to the flow meter.
4. Connect a calibrated manometer to the fittings. Please verify the high pressure and low pressure sides of the meter when connecting the manometer. Secure the tubing to the fittings and manometer to prevent leakage during testing.
5. Apply pressure to the meter.
6. Set the actual flow rate to a value tested on the original Calibration Report.
7. Once setpoint has been achieved, verify the differential pressure on the manometer is within the tolerance indicated for that point in the Verification Data section
  - a. *If the differential pressure reading is out of tolerance, verify the pressure and temperature values match the values listed under the "Calibration Condition" section of the "Certificate of Calibration". If the values are different, you will need to use the equation given on the cert, along with the actual pressure and temperature readings to obtain new differential pressure points. These values can be found in the keypad in the setup menu under the P1.10 & P1.20 parameters or in the touchscreen Process Variable Menu.*
8. Once the verification is complete, close the supply pressure to the meter to purge the meter of pressure. Remove the manometer from the fittings and reinstall the plugs using proper thread sealant.
9. If the meter is determined to be out of tolerance, continue to the "Sensor Accuracy Verification" section of the manual
10. If the sensors are determined to be within tolerance but the flow rates are not, the meter may need to be recalibrated by SSI if necessary. Please contact SSI for next steps.

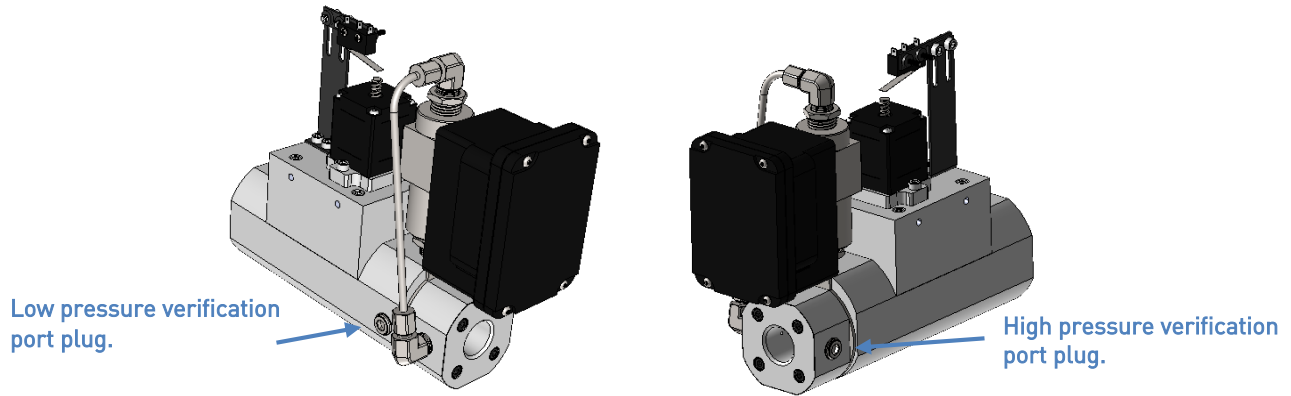

eFlo calibration verification port locations

### Sensor Accuracy Verification

The following procedure should be used for verifying the accuracy of the installed pressure sensors

#### Items needed

- Calibrated Manometer with a usable range of 0 – 27.7 ”wcg (0 – 1 PSI)

#### Procedure

1. Connect the high and low pressure ports of the manometer to the high and low pressure ports of the flow meter with the necessary tubing and open the ball valves
2. Go to the “Process Variables” section of the setup menu and check the indicated differential pressure reading. This is found in the P1.30 parameter of the keypad or the Process Variable menu of the touchscreen.
3. The differential pressure reading on the flow meter should be +/- 4% full scale of the compared reading of the manometer
  - a. *Example: a full scale reading of 12”wcg should be +/- 0.48”wcg*
4. If the sensors are determined to be out of tolerance, the sensors may need to be replaced. Please contact SSI for next steps.

По вопросам продаж и поддержки обращайтесь:

Алматы (7273)495-231  
 Ангарск (3955)60-70-56  
 Архангельск (8182)63-90-72  
 Астрахань (8512)99-46-04  
 Барнаул (3852)73-04-60  
 Белгород (4722)40-23-64  
 Благовещенск (4162)22-76-07  
 Брянск (4832)59-03-52  
 Владивосток (423)249-28-31  
 Владикавказ (8672)28-90-48  
 Владимир (4922)49-43-18  
 Волгоград (844)278-03-48  
 Вологда (8172)26-41-59  
 Воронеж (473)204-51-73  
 Екатеринбург (343)384-55-89

Иваново (4932)77-34-06  
 Ижевск (3412)26-03-58  
 Иркутск (395)279-98-46  
 Казань (843)206-01-48  
 Калининград (4012)72-03-81  
 Калуга (4842)92-23-67  
 Кемерово (3842)65-04-62  
 Киров (8332)68-02-04  
 Коломна (4966)23-41-49  
 Кострома (4942)77-07-48  
 Краснодар (861)203-40-90  
 Красноярск (391)204-63-61  
 Курск (4712)77-13-04  
 Курган (3522)50-90-47  
 Липецк (4742)52-20-81

Магнитогорск (3519)55-03-13  
 Москва (495)268-04-70  
 Мурманск (8152)59-64-93  
 Набережные Челны (8552)20-53-41  
 Нижний Новгород (831)429-08-12  
 Новокузнецк (3843)20-46-81  
 Ноябрьск (3496)41-32-12  
 Новосибирск (383)227-86-73  
 Омск (3812)21-46-40  
 Орел (4862)44-53-42  
 Оренбург (3532)37-68-04  
 Пенза (8412)22-31-16  
 Петрозаводск (8142)55-98-37  
 Псков (8112)59-10-37  
 Пермь (342)205-81-47

Ростов-на-Дону (863)308-18-15  
 Рязань (4912)46-61-64  
 Самара (846)206-03-16  
 Санкт-Петербург (812)309-46-40  
 Саратов (845)249-38-78  
 Севастополь (8692)22-31-93  
 Саранск (8342)22-96-24  
 Симферополь (3652)67-13-56  
 Смоленск (4812)29-41-54  
 Сочи (862)225-72-31  
 Ставрополь (8652)20-65-13  
 Сургут (3462)77-98-35  
 Сыктывкар (8212)25-95-17  
 Тамбов (4752)50-40-97  
 Тверь (4822)63-31-35

Тольятти (8482)63-91-07  
 Томск (3822)98-41-53  
 Тула (4872)33-79-87  
 Тюмень (3452)66-21-18  
 Ульяновск (8422)24-23-59  
 Улан-Удэ (3012)59-97-51  
 Уфа (347)229-48-12  
 Хабаровск (4212)92-98-04  
 Чебоксары (8352)28-53-07  
 Челябинск (351)202-03-61  
 Череповец (8202)49-02-64  
 Чита (3022)38-34-83  
 Якутск (4112)23-90-97  
 Ярославль (4852)69-52-93

Россия +7(495)268-04-70

Казахстан +7(7172)727-132

Киргизия +996(312)96-26-47